

# Installation Instructions

## Bird Spike 2001<sup>®</sup> Stainless Steel Bird Spike

Bird B Gone<sup>®</sup> patented Bird Spike 2001<sup>®</sup> is the most effective, permanent protection to deter birds from landing and roosting. Bird Spike 2001<sup>®</sup> is made of high-quality stainless steel that will not rust or deteriorate under extreme conditions. The U.V. protected polycarbonate bird spike base is flexible, can bend 360°, and will fit both flat and curved surfaces. Bird Spike 2001<sup>®</sup> has an industry leading guarantee of 10-years and is available in 1", 3", 5", and 8" widths.

***BIRD SPIKES ARE NOT RECOMMENDED IN AREAS WHERE BIRDS ARE NESTING.***

### APPLICATIONS

Bird Spike 2001<sup>®</sup> is a versatile system that can be easily glued, screwed, or tied down to various surfaces.

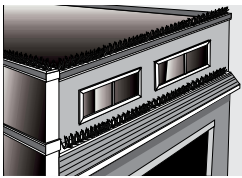

#### Ledges:

Bird Spike 2001<sup>®</sup> prevents pest birds from congregating on ledges, sills, roof tops, etc. Installing Bird Spike 2001<sup>®</sup> will stop birds from landing, roosting, and creating unsightly messes and health problems.

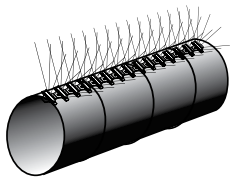

#### Conduit:

Bird Spike 2001<sup>®</sup> can be attached to wires, conduit, gutters, and pipes by using common hose clamps, nylon ties, wire, or glue.

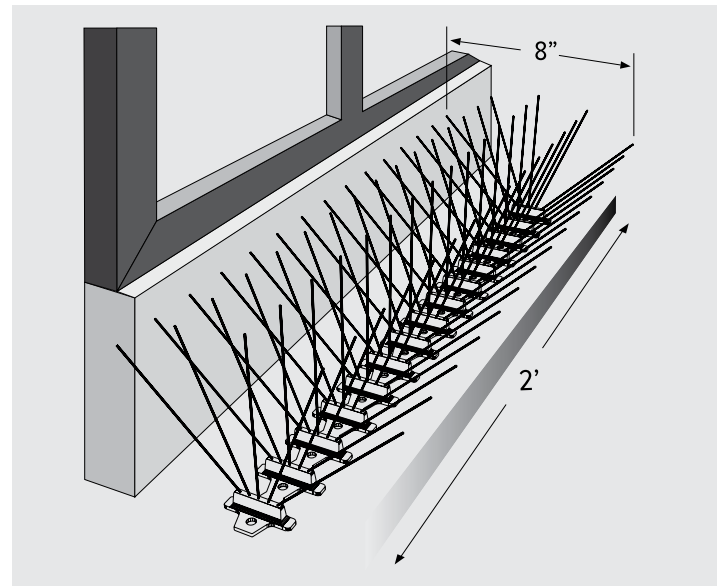

Bird Species	Pigeons, seagulls or larger birds
Bird Pressure	Light to Medium
Where to Use	Ledges, I-beams, parapet walls, conduits, signs, flat or curved surfaces
Warranty	10-year manufacturer's warranty
Commercial Packaging	50 ft. per box (25 – 2 ft. sections/box) Each box measures 26" x 19" x 7"

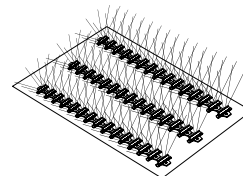

#### Large Flat Surface:

Bird Spike 2001<sup>®</sup> can be installed in multiple rows for a wider area of coverage.

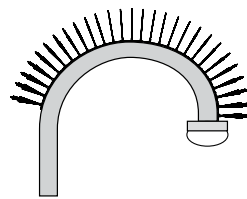

#### Curved Surfaces:

Bird Spike 2001<sup>®</sup> is so flexible that it can bend 360° without breaking. Install Bird Spike 2001<sup>®</sup> by using outdoor construction-grade adhesive in conjunction with nylon ties, hose clamps, etc. on all curved surfaces such as lampposts, signs, letters, etc.

***Installation questions?***

***Call 877-708-1974***

# Installation Instructions

## Bird Spike 2001<sup>®</sup> Stainless Steel Bird Spike

**CAUTION: READ AND FOLLOW ALL INSTRUCTIONS PRIOR TO INSTALLATION. SPIKES ARE SHARP. WEAR PROPER PERSONAL PROTECTION GEAR. KEEP OUT OF REACH OF CHILDREN AND PETS. DO NOT INSTALL WHERE HUMAN PHYSICAL CONTACT IS POSSIBLE. VISIT [BIRDBGONE.COM/SAFETY](http://BIRDBGONE.COM/SAFETY).**

### 1. DISINFECT AND CLEAN ALL SURFACE AREAS

Remove all debris including overhanging branches, leaves, nests, etc. Clean and disinfect area using hospital grade disinfectant. We recommend Microcide SQ™. Allow area to dry before installation. Visit [birdbgone.com/safety](http://birdbgone.com/safety) for additional information.

***DUE TO INFECTIOUS DISEASES ASSOCIATED WITH BIRD FECES, USE EXTREME CARE WHEN REMOVING NESTS AND BIRD DROPPINGS.***

### 2. DETERMINE THE METHOD OF ATTACHMENT

**For Concrete, Brick, Steel:** Adhere bird spike strips using outdoor construction-grade adhesive. Run a bead of adhesive along the glue trough on the underside of each bird spike strip. Press bird spike strip into place, allowing the adhesive to mushroom-up through the screw holes for more effective adhesion. For a list of recommended adhesives, visit our website at [birdbgone.com](http://birdbgone.com). One caulking tube of adhesive will adhere approximately 25 ft. of Bird Spike 2001<sup>®</sup>.

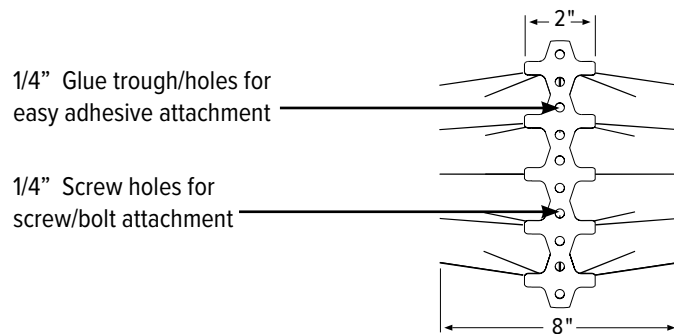

**For Wood:** Use wood screws to secure bird spike strips to wood surfaces. Following pre-drilled holes along the bird spike strip base, screw tightly into the end of each strip; place one wood screw at least every six inches along the strip base.

**For Pipes:** For pipes and other areas, secure bird spike strips with nylon ties by wrapping and securing the tie around the base of the bird spike strip.

**NOTE: WHENEVER POSSIBLE, BIRD SPIKE STRIPS SHOULD BE GLUED, SCREWED, OR TIED DOWN IN CONJUNCTION WITH AN OUTDOOR CONSTRUCTION-GRADE ADHESIVE.**

### 3. SPIKE PLACEMENT

- To prevent birds from nesting behind the spike, leave no more than 1" gap between the wall and the bird spike strip.
- To prevent birds from sitting on the ledge, leave a minimum of 1/2" overhang between the tip of the bird spike and front/leading edge.

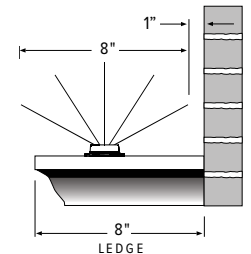
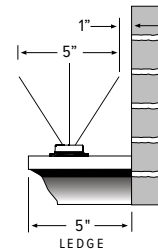

- Wider ledges, may require multiple rows of bird spike strips. Install bird spike strips with 1" overlap.

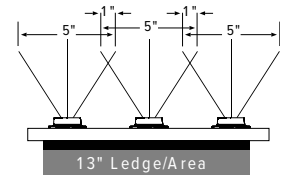

### 4. ADAPTING TO SIZE

- Bird Spike 2001<sup>®</sup> can be easily cut to desired size using tin snips, wire cutters, or snapped apart by hand along the narrow section of the bird spike strip base.

**Installation questions?**

**Call 877-708-1974**